

NMF.300 - MANYETİK FRENİN ÖZELLİKLERİ

GÜCÜ	:	2 x 105	Watt
VOLTAJI	:	198	Volt DC
NOMİNAL AKIMI	:	2 x 0,530	A
YÜKÜ	:	1.275	Kg
TORKU	:	2 x 850	Nm

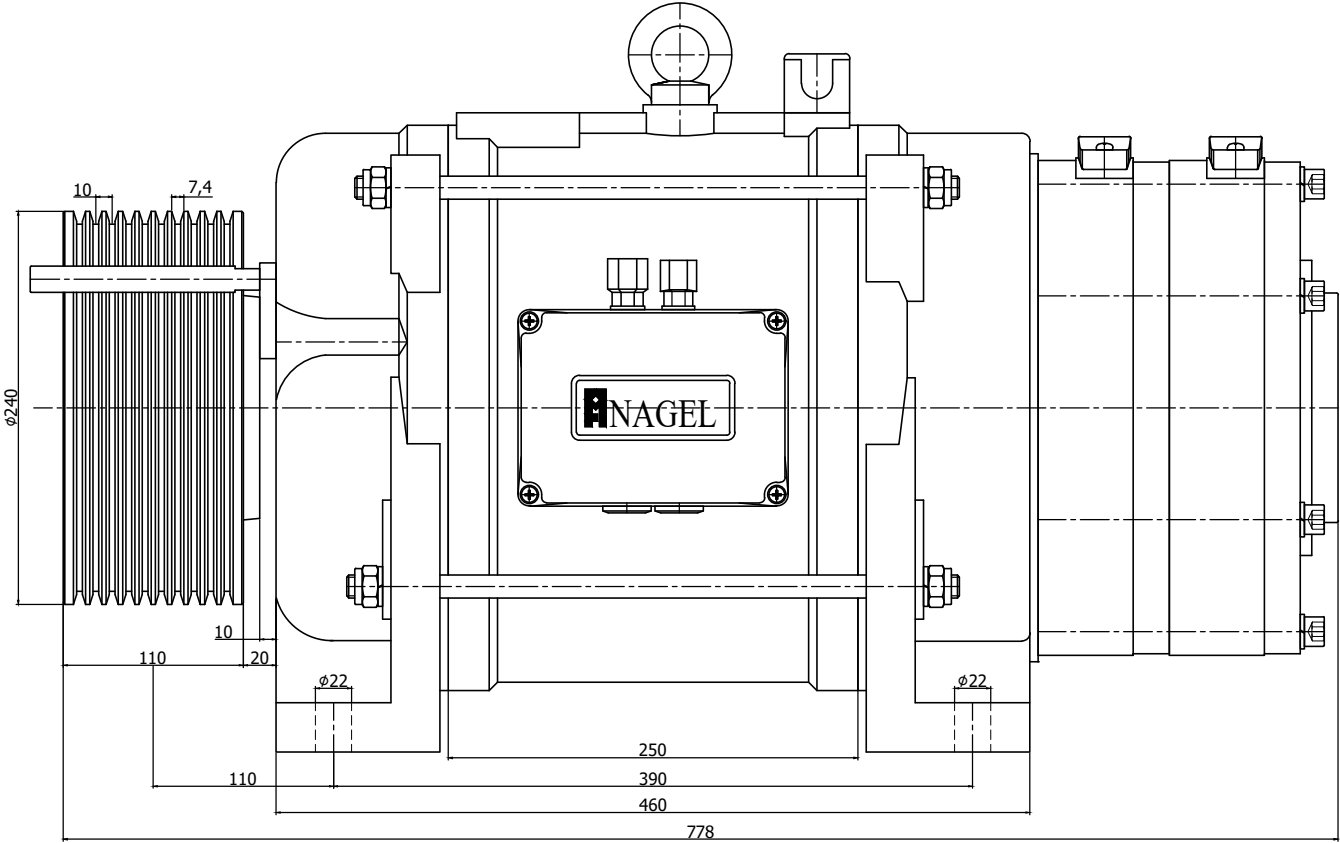

Not : a) 2:1 Askıda 30 metreden sonra denge zinciri kullanılmalıdır.

b) Firmamız ürünlerinde haber vermeksizin değişiklik yapma hakkı saklıdır.

Notes : a) Elevator balance compensation chain should be used when the distance is higher than 30 m

b) We reserve the right to change the terms and conditions.